

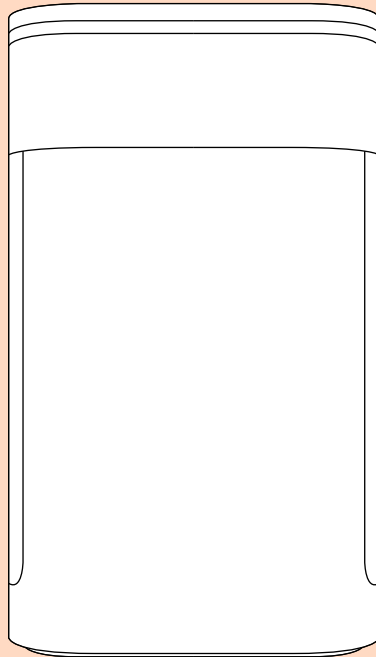

**LEGATE**<sup>™</sup>  
Smart home

# SMART AIR PURIFIER PREMIUM

Manual Guide



Legate Smart Appliances



# Let's Get Started.

---

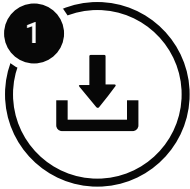

## Install the app

Download the **Legate Smart Home** app from Google Play or the App Store on a compatible phone or tablet.



## Register and login

Register on the app by using your contact number or Email address.



## Connect to wifi

Make sure that your mobile phone and smart device are connected to 2.4 GHz wifi network.

\*note: The distance between the phone and smart device should not be greater than 4meters while pairing both devices. If the signal is week you'll need a wifi booster. (Recommended Wifi Booster Version: **TP LINK TL-WA855RE**)

**Legate Smart Air Purifier Premium  
to Legate Smart Home App**

## Getting the Smart Device Ready

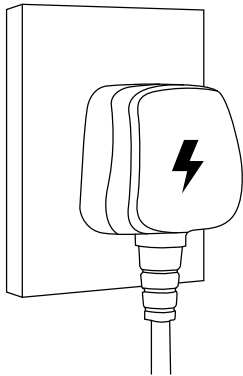

1

Plug the **Power Plug** into the power socket.

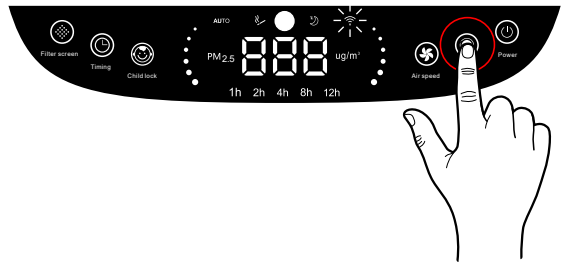

2

Turn on the Smart Air Purifier, press & hold the **Mode Button** for 5 seconds until the Wifi Indicator Light blink rapidly.

## Add Smart Device

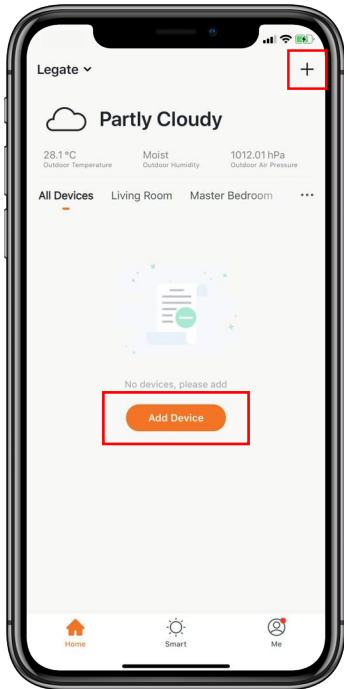

3

Open Legate Smart Home app,  
Click “+” or **Add Device**.

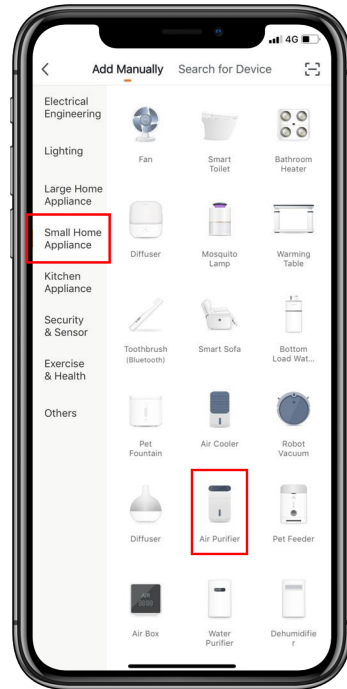

4

Under “**Small Home Appliances**” tab  
Click “**Air Purifier**”.

## Network Configuration



5

Click **“Confirm indicator rapidly blink”** button.

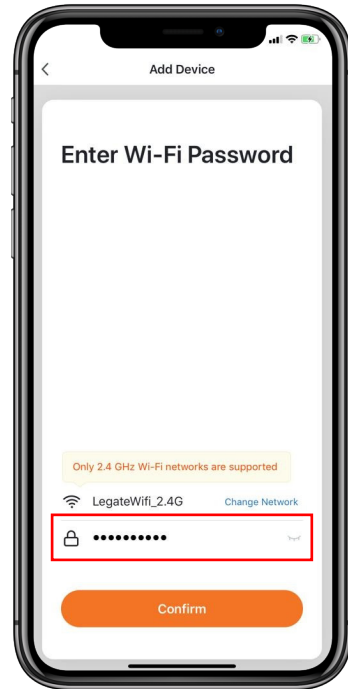

6

Enter your **Wifi Password**. Then click **“Confirm”** button.  
(note: Only 2.4 GHz Wifi network are supported)

## Network Configuration

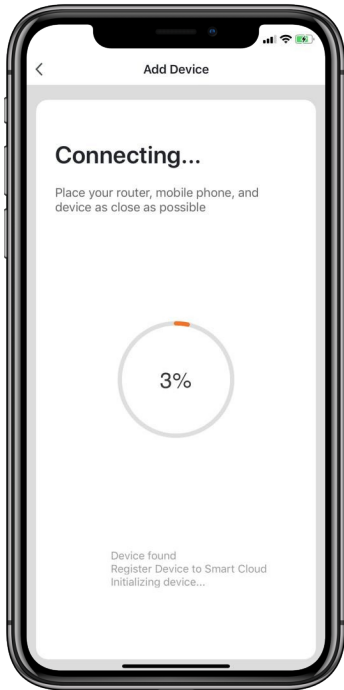

7

Wait for the Smart Device connects to the app.

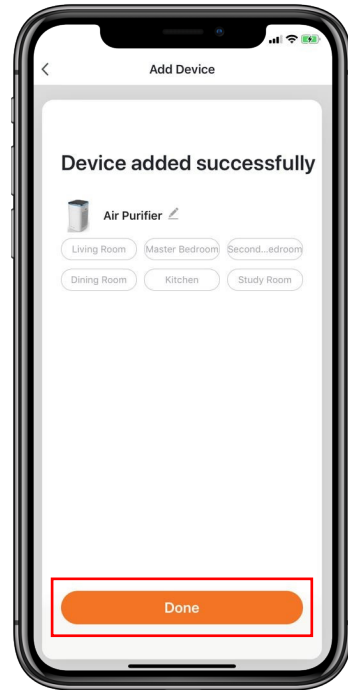

8

Click **“Done”** button when the Smart Device is successfully added.  
(note: You can change the device's name)

# **Legate Smart Air Purifier Premium Features**



## Main Function

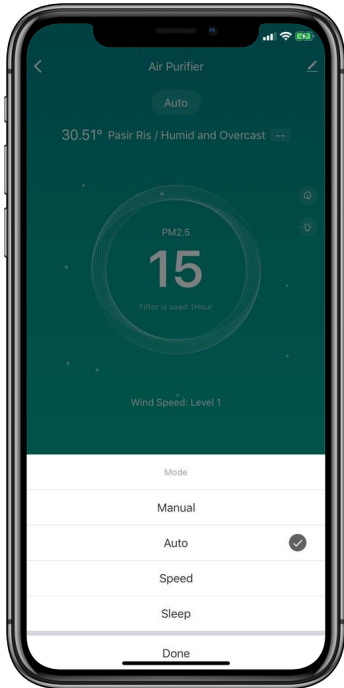

Set the **Mode Settings** of the Smart Air Purifier.

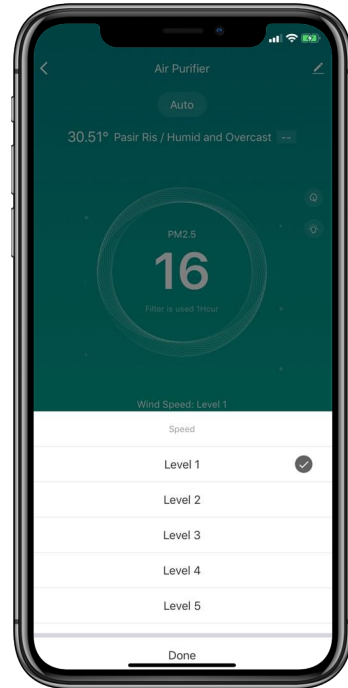

Adjust the **Speed Level** of the Smart Air Purifier's fan.

## Main Function

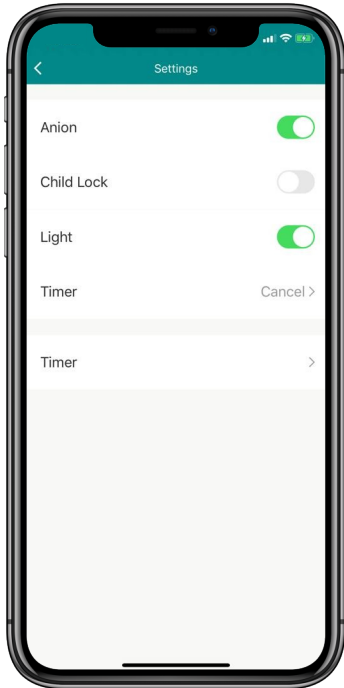

**Enable or Disable** the different functions of the Smart Air Purifier.

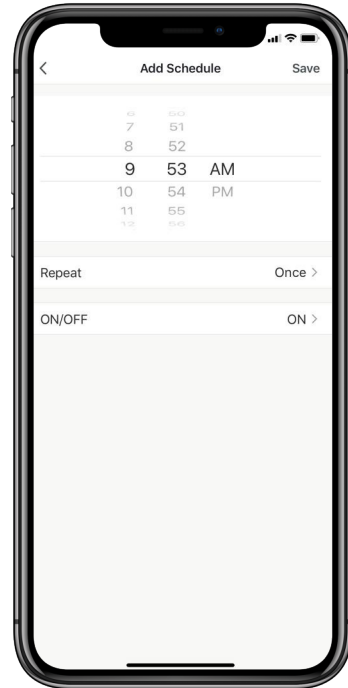

**Set Schedule** to automatic turn ON/OFF the Smart Air Purifier.

# Push Notification

Enable to turn off the notification.

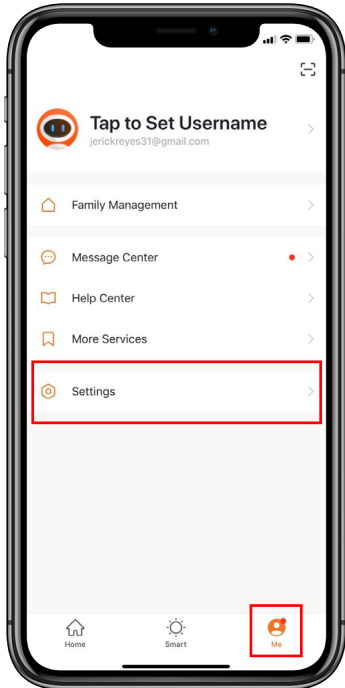

1

Click **"Me"** button on Legate Smart Home app. Then click **"Settings"**.

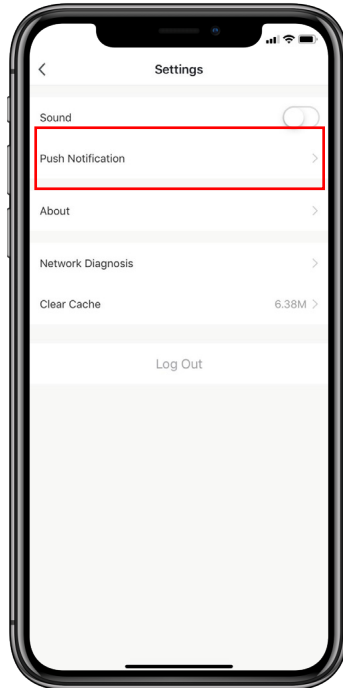

2

Click **"Push Notification"** tab.

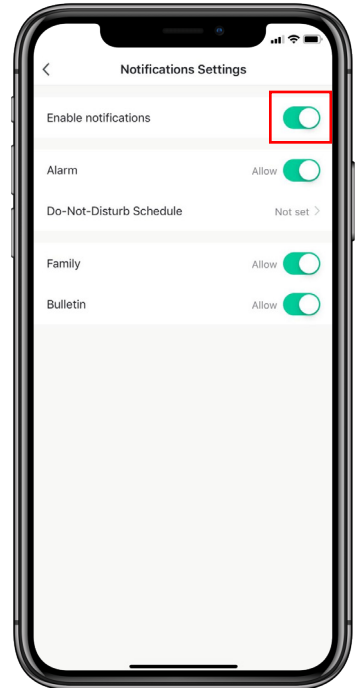

3

Can turn on or turn off the **"Enable notification"**

## Remove Device from Legate Smart Home app

The device will restore to default settings.

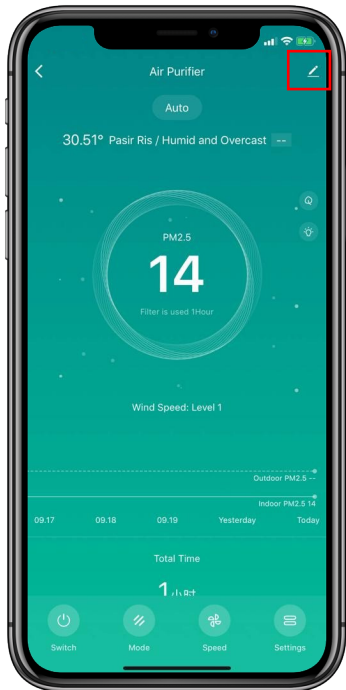

1

Click “✎” button on upper right corner of Smart Camera main page.

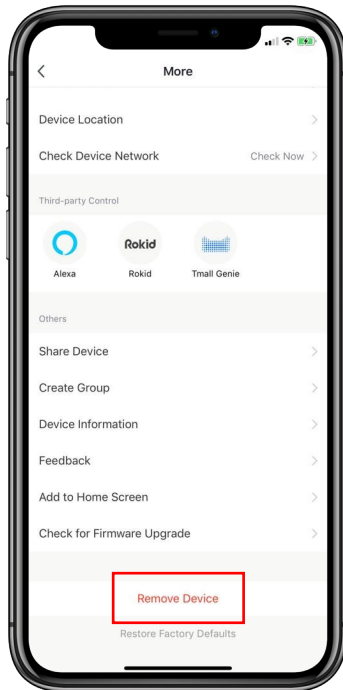

2

Click “**Remove Device**” tab.

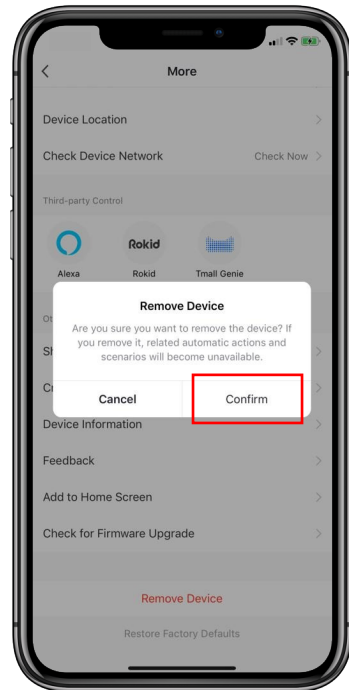

3

Click “**Confirm**” button to completely remove the device from the Legate Smart Home app.

# **Legate Smart Air Purifier Premium Product Information**

## Product Features

---

### Functions

- To purify gaseous pollutants such as smoke, dust particles and formaldehyde.
- To realize the sterilization and air purification of large-space houses, offices, restaurants, bars and entertainment places.

### Cold Catalyst Filter

- Air quality is shown by the four-color LED atmosphere light.
- Double filter screens generate clean air of double volume.
- The built-in high-precision particle sensor detects air quality in real time.
- WiFi function, manual operation control, night sleep automatic control and infrared remote control.
- MANUAL, AUTO, TOPSPEED and NIGHT models.

### Characteristics of Filter Screen

- Primary filter screen: To filter out large particles such as human hair, pet hair, cotton wool and other substances.
- HEPA composite filter screen: To filter out smoke, dust, pollen, oxygen source, pollutant and fine particles over 0.3 micron, together with harmful gas such as benzene, formaldehyde and odor.

## Packing Details

---

Body	1PC
Primary Filter Screen	2PCS
HEPA Composite Filter Screen	2PCS

WiFi Specifications	1PC
Remote Control	1PC

## Product Performance

Product Name	Air Purifier
Model	KJ800F-K15C
Use	To eliminate the pollutants such as particulate matters (PM), gaseous pollutants, microorganisms and the like in air.
PM CADR	800m <sup>3</sup> /h
PM CCM	P4
Aseous Pollutant CADR	488 m <sup>3</sup> /h
Gaseous Pollutant CCM	90 m <sup>3</sup> /h
Noise	≤66dB(A)
Applicable Area	56 ~ 96m <sup>2</sup>
Mode of Operation	Intelligent Purification
Rated Voltage	220V - 240V
Rated Frequency	50Hz / 60Hz
Rated Power	85W
Size (LxWxH)	40x 40 x 66.9 cm
Net weight	14.0 KG

# Product Structure

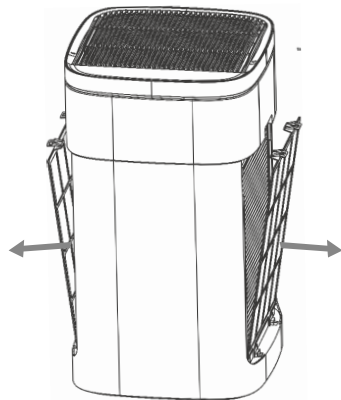



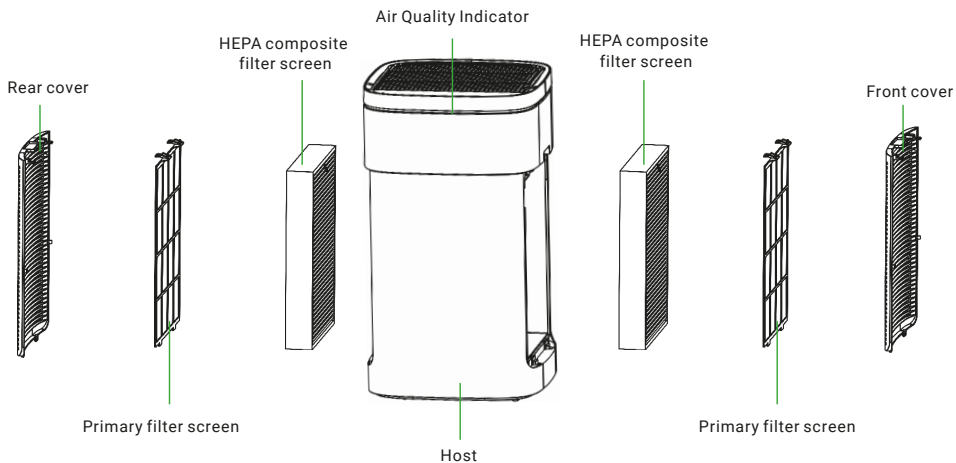





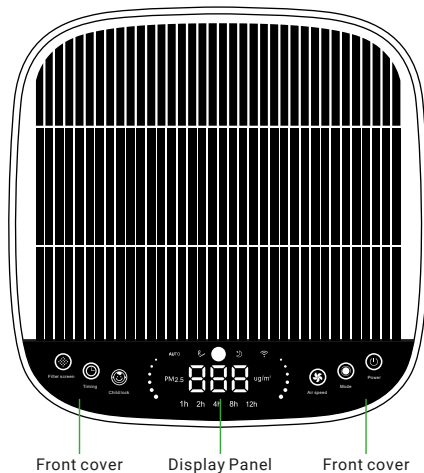



Remote controller







## Key & Display Panel



	Standby	Power on
Switch key	 Red	 Green
Function key		
Mode 	Air speed 	Child lock 
Timing 	Filter screen 	AUTO 
topspeed 	SLEEP 	WiFi 

## Replacement reminder for Filter Screen

The machine is designed with a reminder for regular replacement of filter screen. When the machine has been operated for 300 hours, the red indicator flashes to indicate the need of cleaning the filter screen. When the machine has been running for 3,000 hours, the red indicator on the panel will be on normally to indicate the need of replacing the filter screen. At this time, the reset function of the key comes into effect. Keep pressing the key to reset the timing and re-start the timing.

	Normal	Due
Primary filter screen	No display	 The flashing red indicator, indicates the cleaning of the filter screen.
HEPA composite filter screen	No display	 The normally-on red indicator, indicates the replacement of the filter screen.

## PM Value Correspondence Table

PM2.5 concentration ug/m <sup>3</sup>	1-35	36-75	76-150	151-500
Air quality	(Blue) Good	(Green) Fair	(Orange) Bad	(Red) Dirty

## Requirements on placement

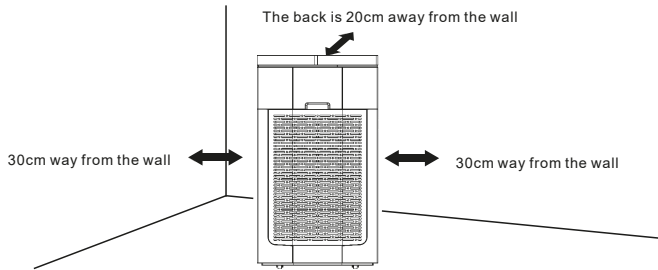

In the operation, the back of purifier should be kept 20cm away from the wall, and over 30cm on both sides.

## Installation of Filter Screen

### 1. Take out the filter screen from the plastic bag.

A. Remove the front and rear covers

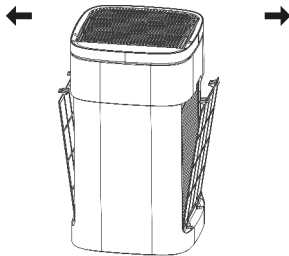

B. Remove the filter screen

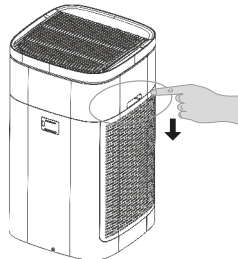

C. Take out the filter screen from the plastic bag

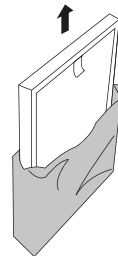

## Installation of Filter Screen

### 2. Install the filter screen and the front and rear covers.

A. Install the HEPA composite screen  
Note: One side of the strap is installed outward

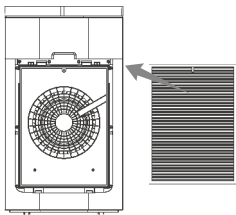

B. Install the primary filter screen (with internal and external differentiation)  
Note: The side with buckle is installed outward

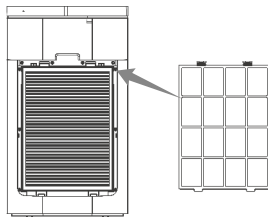

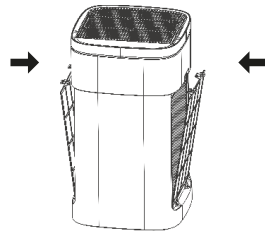

C. Install the front covers.



## Methods of Use

### 1. Power it On.



For first use, firstly take out the product from the packaging box, remove the binding wire of power cord, and then insert the plug into the power socket. When energized, the power key icon on the product panel will display red.

Gently touch  the machine to turn it on. Then the POWER key changes to green , and the machine enters the AUTO mode by default. At the same time, the front panel of the machine displays: AUTO (automatic mode).

## Control Overview

---

### 2. Mode Selection

AUTO  , TOP SPEED  and SLEEP  . When the AUTO light is on, the anion is turned on, and the gear of the motor is changed upon receiving the data of the sensor. (The icon of the key is on when the AUTO function is on, and the icon is half-lit when it is turned off).

When the TOPSPEED light is on, the machine enters the TOPSPEED model. When the SLEEP light is on, the SLEEP function is turned on, and only the SLEEP light is half-lit. The machine can only work in the SLEEP mode and is not controlled by the sensor.

### 3. Manual

In the startup state, touch the AIR SPEED key to switch the gear of the motor and adjust the operating speed of the machine. The motor is not controlled by the sensor after the man-made modification of the motor gear, and the motor can only work on the currently set gear.

### 4. Child Lock

In the startup state, press the CHILD LOCK key to enter the key locking state. At this time, all the keys are in the state of being unable to be touched or controlled, but the machine works in the pre-locked setting state. And then press the Child Lock for 5 seconds to release this state. (The icon of the key is on when the child lock function is activated, and half-lit when released.)

### 5. Timing

Press this key to set timing shutdown in the startup state. Touch the TIMING key, and then the timing function will be added for 1 hour every time. After pressed for 12 hours, press it again for release the timing function. The timing shall be set in the range of 1-12 hours. (The icon of the key is on when the timing shutdown function is activated, and the icon is half-lit when deactivated.)

## Control Overview

### 6. WiFi

The MODE key can be long pressed for 5 seconds in both startup and shutdown modes. Then this pattern flashes. At this time, the machine enters the state of pairing with the mobile phone APP. Refer to the mobile phone APP operation methods specified on the Wi-Fi instructions folding. The pattern will be normally on after successful pairing.

This pattern does not light when there is no WIFI signal in the environment in which the machine is located. When the machine is powered on, the pattern is slowly flashing when the WIFI signal is received, and normally on when the machine is connected.

If the machine has been paired with the WIFI before and it has the memory function, the machine can control the start-up, shutdown and other functions by the WIFI in the standby state.

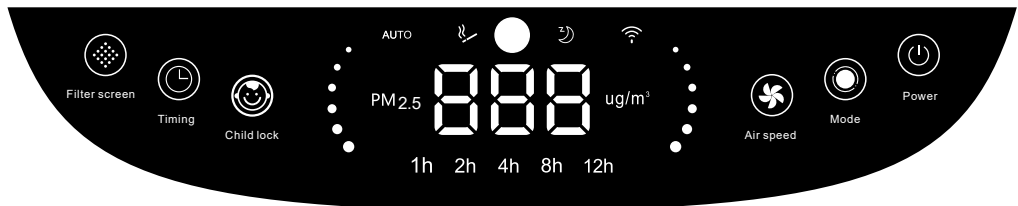

## Maintenance & Service

1. **Primary filter screen:** The cleaning frequency of the primary filter screen should be determined according to the air speed, air pollution degree and cumulative operation time of product operation. It should normally be cleaned once normally for 2-3 months. Please clean it in time, otherwise the purification efficiency of the air purifier will be affected.
2. **HEPA composite filter screen:** The multifunctional composite filter, which is composed of the HEPA, the adsorption and purification material, the catalytic purification material and the functional filter material, can effectively purify the suspended particles, virus and bacteria in the air and effectively remove peculiar smell and harmful gas.



### 3. Cleaning of primary filter screen:

- A) Turn off the power supply and pull the power plug off the socket.
- B) Place the hand in the position of the handle and open it at a certain angle outwards. At this time, lift the back cover up to a certain distance and take down it from the product.

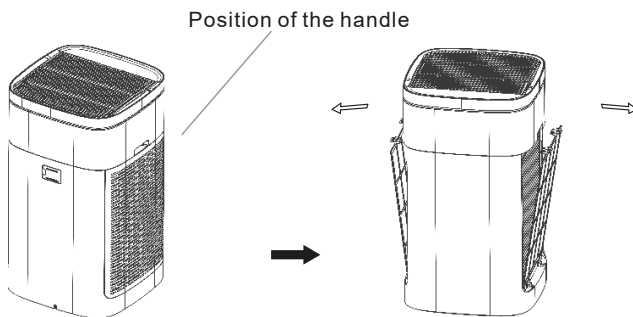

## Maintenance & Service

C) Grasp the two straps on the primary filter screen and pull out them gently, and then pull the primary filter screen upwards. Take care to avoid flying dust.

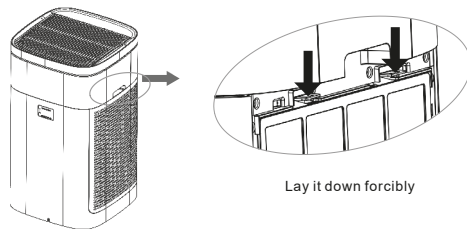

D) Cleaning methods: Clean the dust and floc with vacuum cleaner or brush. If the filter screen is very dirty, it can also be cleaned with water, and then dried completely, and then installed back to the purifier. (It cannot be bent in the cleaning so as to avoid damage)

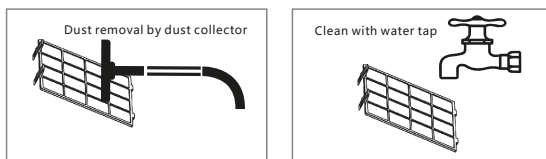

E) Installation methods: Insert the insertion piece below the filter screen into the corresponding card slot (pay attention to the direction of the filter screen. The two straps should be outward), and then buckle up the upper buckle.

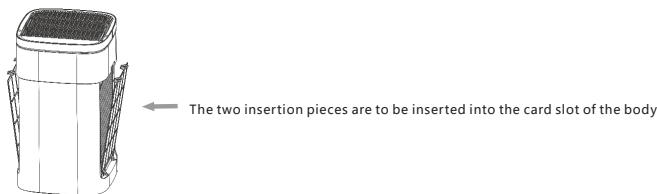



## Maintenance & Service

F) Install the filter assembly back to the product: Place the HEPA composite filter screen, the primary filter screen and the front cover respectively in the corresponding clamping positions of the machine, insert the insertion pieces into the corresponding clamping grooves, and then make the front cover engaged with the machine body.

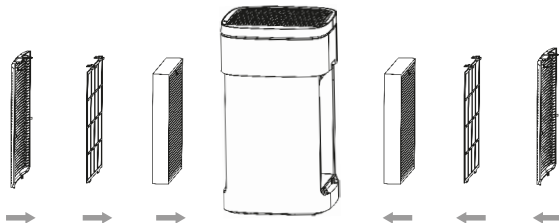

### 3. Intelligent reminder for filter screen replacement:

- Turn off the power supply and pull the power plug off the socket.
- Open the rear cover and take down the primary filter screen according to the same method specified in "Cleaning of primary filter screen".
- Take out the HEPA composite filter screen to be replaced from the frame of the machine according to the replacement indication of the display panel, and then put the new filter screen into the filter screen frame in sequence, and lastly install the filter assembly back on the machine.

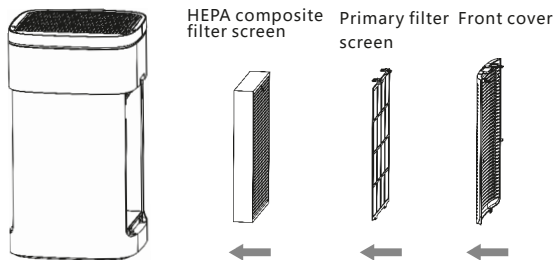

## Maintenance & Service

D) Turn on the power supply. In startup state, when the red light is normally on, press the FILTER SCREEN key for 5 seconds for resetting and new timing. In the normal startup state, press the FILTER SCREEN key, and then the accumulated working time (in hour) of the filter screen will be displayed on the display. Since there are only three digital displays, the display screen first displays a thousand-digit value, and then hundred-digit, ten-digit and single-digit values. Please read with the four values together.

(The following figure shows the display mode of 2802 hours)



Filter screen



First time display:  
thousand-digit value



Second display:  
hundred-digit,  
ten-digit and single-digit values

E) Pull off the power supply and install the rear cover on the product body.

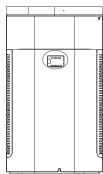

Take down the dust cover, and then clean the lens of sensor with a vacuum cleaner or blower

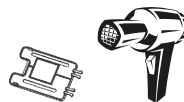
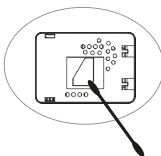

Clean the cover of air sensor with a vacuum cleaner or blower

### 5. Cleaning of the machine

Cleaning of the host surface:

Clean the dirt with a dry wipe, Do not wash the machine with water.

## Maintenance & Service

Cleaning of air outlet:

- A) Cut off the power and pull the plug off the power socket.
- B) Place the hand on the side of air outlet grille with ▲, and turn it up and take it off.
- C) Take out the air outlet grille when the machine is in operation, and then the machine stops running. Install it back to the machine, and then the machine continues with the operation before the power-off.

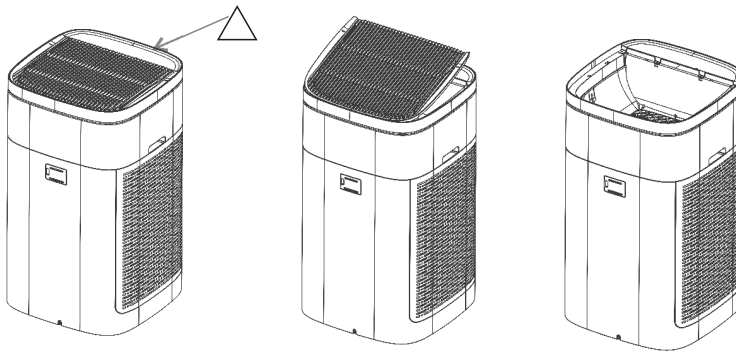

### 6. Maintenance and cleaning of Anion Generator:

When the machine sounds “creak”, the anion generator needs to be cleaned. Take out the air outlet grille, and stir and clean the dust on the anion emitter with cotton swab from the iron net over the emitter. This cleaning should be carried out on a regular basis.

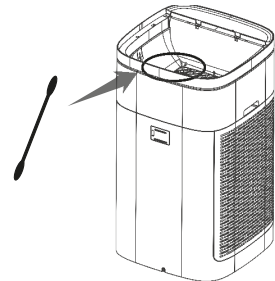







## Precautions

### Safety Precautions

When humidity in the room is very high, the air quality sensor may form condensed water. In this case, in the AUTO mode, even if the air quality is good, the status light on the panel will show poor air quality. It is recommended that you manually select the air volume.

### Warning

 No wet hands!	<p>Do not contact the power plug with a wet hand.</p>	 Pull out the plug!	<p>Make sure to disconnect the power supply before cleaning the machine.</p>
 Not	<p>Do not use other forms of power. Only AC220V50HZ can be used as power source. The user must not open the case for maintenance. The maintenance must be operated by professional maintenance personnel. Do not pour water or liquid or flammable cleaning agent into the product so as not to cause damage to the product or cause fire due to electric shock.</p>		<p>In the operation, the back of purifier should be kept 20cm away from the wall, and over 30cm on both sides. Place the product in a dry and smooth horizontal plane and keep it away from heat source and too wet location.</p>
 Not	<p>Do not clean the body with solvents or chemical liquids in order to avoid corrosion of the body. Do not place the hand or any object into the air outlet. Do not pull the power cord from the power supply. The plug should be removed safely by holding the power socket. Do not place any articles at the air inlet and outlet, so as not to affect the flow of the air and reduce the purification efficiency.</p>		<p>Remove the power plug when the machine will not be in use for a long time. Pay attention to child who should not come into contact with and use the purifier. Keep the smooth air flow in the air inlet. Do not let dust, lint, hair or other substances block the air inlet.</p>

# Troubleshooting

Common faults	Check/Solutions
The machine can't start up (the power light does not light in red)	1. Is the power cord plug inserted properly? → Plug in the power cord plug. 2. Are the left and right air inlet plates of the purifier well covered? → Cover the left and right air inlet plates of the purifier.
The machine can't start up (the power light is flashing). There is no response when pressing the key.	Is the top air outlet grille properly installed? Note that the direction of the air outlet grille should be correct → Install the top air outlet grille in place.
The air is polluted, but the air pollution indicator is still green	Is the purifier placed in a place where dirty air (dust) is not available? → Change to a new place.
The air pollution indicator is always "Red", even if it is running continuously.	Is the particle sensor dirty? → Clean the particle sensor.
The sound of [snap] and [clank] in operation in operation	Is the anion generator too dusty? → Clean the anion generator.
The smell of the air outlet makes people feel uncomfortable.	1. Is the filter screen dirty? → Clean the filter screen. 2. Has the filter screen not been replaced for a long time? → Replace with a new filter screen.
The machine can't enter the SLEEP mode at night.	Is the purifier operating in MANUAL mode? → Press the "MODE" key on the operation panel and ensure that the purifier is operating in AUTO mode.
The operation time of the purifier is very long, but the air quality is not obviously improved.	1. Is the plastic bag on the purifier filter screen removed? → Please remove the plastic bag on the filter screen before the first use. 2. Is the order of the purifier filter screen incorrect? → See the instructions for installation sequence and precautions.
The alarm light for filter screen is flashing	It indicates that the timing of the primary filter screen has reached the set value. After the filter screen is cleaned, keep pressing the FILTER SCREEN key for resetting.
The alarm light for filter screen is normally on	It indicates that the timing of the HEPA composite filter screen has reached the set value. After the filter screen is cleaned, keep pressing the FILTER SCREEN key for resetting.



**LEGATE**<sup>®</sup>  
Smart home

Your one stop shop for all your Smart Home needs

[www.legate.com.sg](http://www.legate.com.sg)